

Box Frame Solenoid

Oak has been a leading manufacturer of switch products since its founding in 1932. This half-century of manufacturing experience is your assurance of top product quality.

Solenoids are part of Oak's extensive product line which includes switches (rotary, lighted and unlighted pushbutton, lever, rocker, keylock and membrane), full travel membrane-based keyboards and keypads, and subminiature lamps.

Rotary, flat pack, tubular or box frame –Oak has a standard solenoid for virtually any application. And our engineers will be happy to work with your custom designs for special applications, too.

Box Frame Solenoids

Also referred to as "D" frame solenoids, Box Frames provide medium to low power, superior mechanical strength and better heat dissipation. both AC and DC operations are available. Box Frame solenoids are used when improved life and reliability are important.

Box Frame Ordering Guide see page 2 of 3
Type 38 see page 3 of 3

BOX FRAME ORDERING GUIDE

38	C or 25	12 DC or 1260	A	Y	18	L
Solenoid Type	Duty Cycle C-Continuous 25-25% Duty Cycle	Voltage Type 12DC-12VDC 1260-12VAC-60Hz	Plunger External End	Plunger Internal End Y for D.C. X for A.C.	Coil Terminal Type 18-3/16" Standard (QC) LD-Leads Optional	Side of Terminals L-Left Side R-Right Side

STANDARD PLUNGER STYLES AVAILABLE

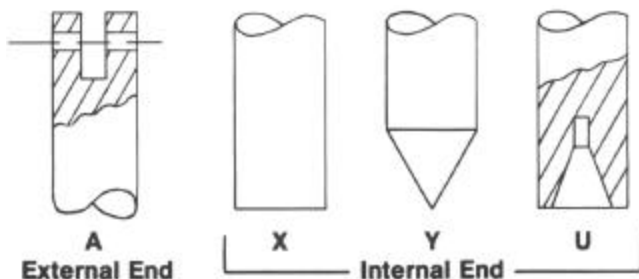

Note:
Special plunger ends can be supplied to customer specifications.

Optional Plunger Ends

Type #34 Solenoid Style "E"

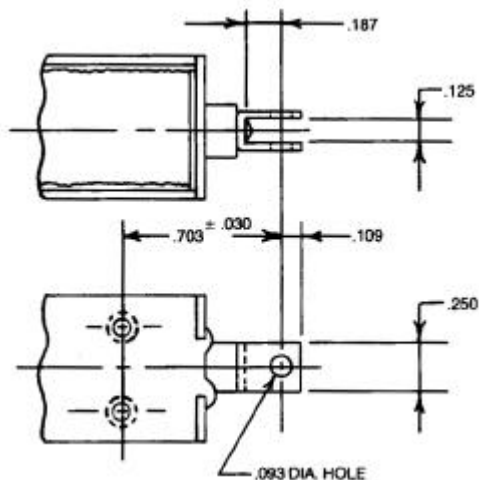

Type #37 Solenoid Style "E"

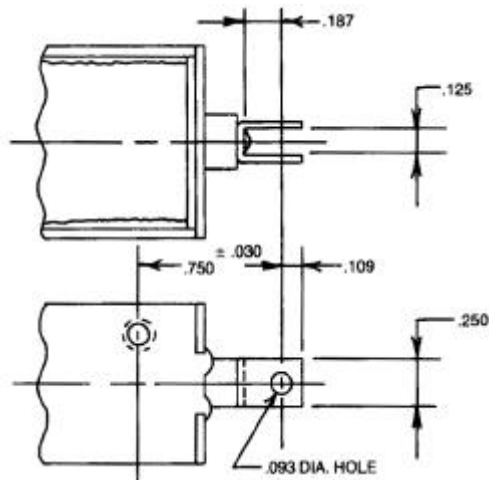

Type #35 Solenoid Style "E"

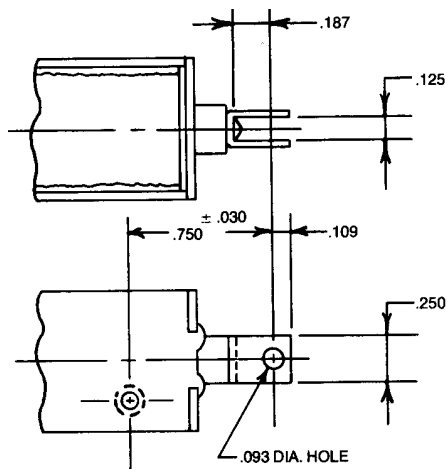

BOX FRAME SOLENOID

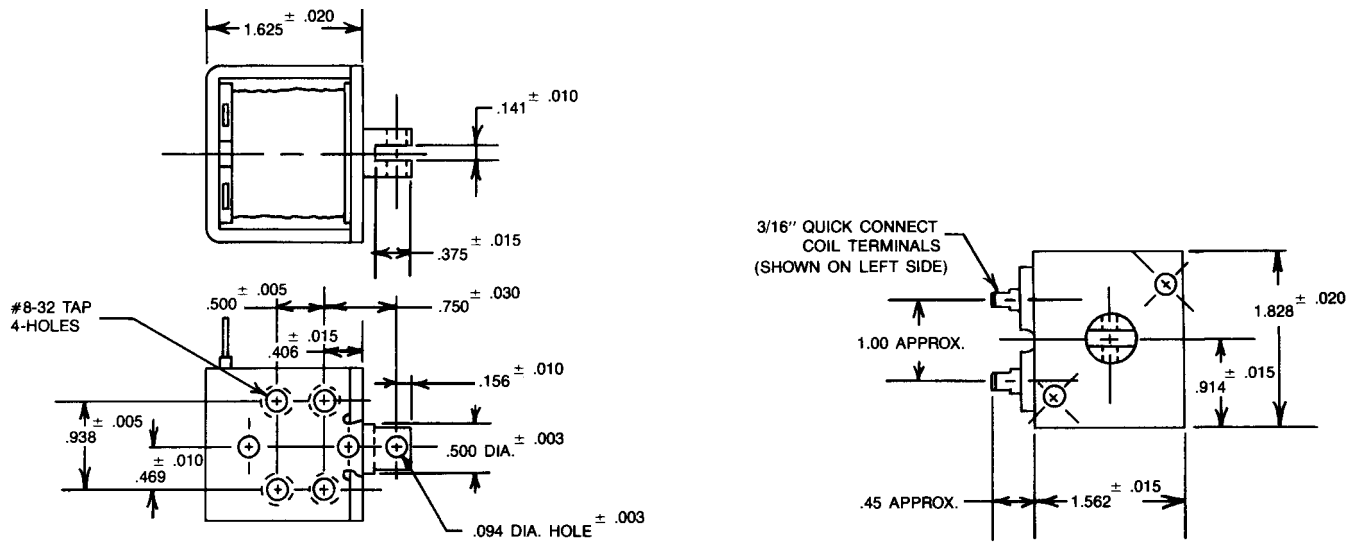

Type 38

Duty Cycle % = on Time	100%	*25%	Duty Cycle % = on Time	100%	*25%
V.A. (Average All Coils)	13.10	66.70	Watts (Average All Coils)	9.79	39.00
Resistance Ohms ± 10%	Voltage A.C.		Resistance Ohms ± 10%	Voltage D.C.	
.28	6	12	4.83	6	12
1.13	12	24	18.20	12	24
4.83	24	--	71.60	24	48
30.82	--	120	282.00	48	--
123.00	120	240	453.00	--	120
453.00	240	--	1908.00	120	240

**FORCE VS. STROKE
AC-60 Hz**

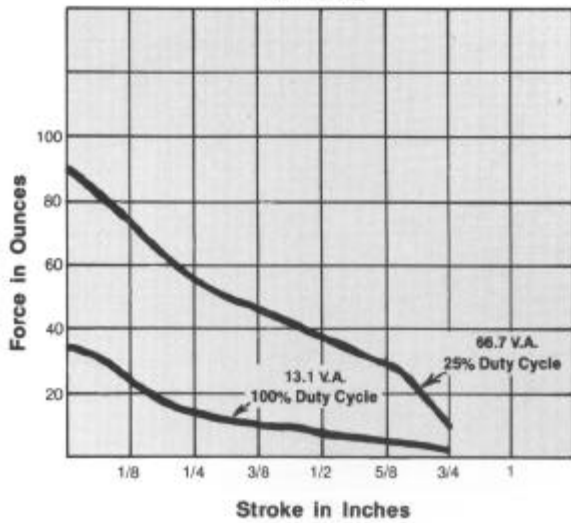

**FORCE VS. STROKE
DC**

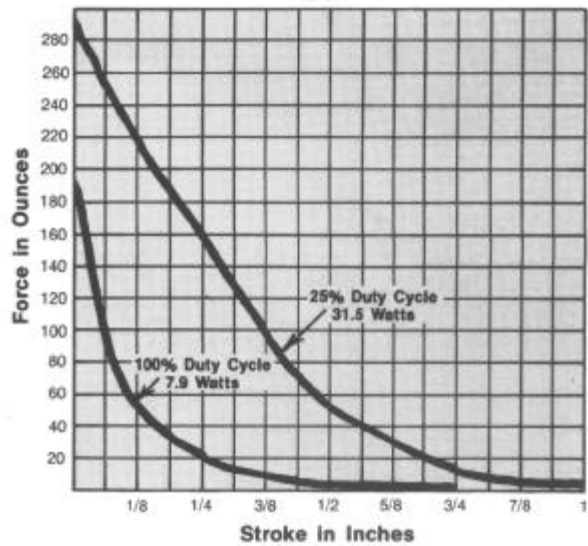

Dielectric Strength: 1,000 + 2 x voltage
 *25% duty cycle is based on 1 minute maximum on time